

MIMO

MIMO from Muraflex.

Minimal. Modern. And so much more.

MIMO de Muraflex.

Minimal. Moderne. Et bien plus encore.

DEMOUNT ABLE PARTI TIONS



CLOISONS AMOVIBLES



Let in more light. Show off architectural elements. Change your floorplan at will. MIMO from Muraflex is not only the most slender and sophisticated demountable wall solution, but also the most versatile, flexible, and convenient. Made from fully recyclable aluminum, frames are available in innumerable colors and finishes and can accept an endless variety of wall materials. Best of all, we are so close and so quick, you'll have elegance on site in half the time you'd expect. All it takes is your ideas and our hardware.

MIMO. Put less between you and your vision.

Laissez entrer la lumière. Affichez l'architecture. Changez votre environnement de travail à votre convenance. MIMO de Muraflex n'est pas seulement le mur démontable le plus raffiné et élégant, mais également le plus versatile, flexible et pratique. Fabriqué à partir d'aluminium entièrement recyclable, les extrusions sont disponibles dans d'innombrables couleurs et finis. Ils peuvent accepter une variété de verres et de panneaux muraux.

MIMO élargit votre vision.

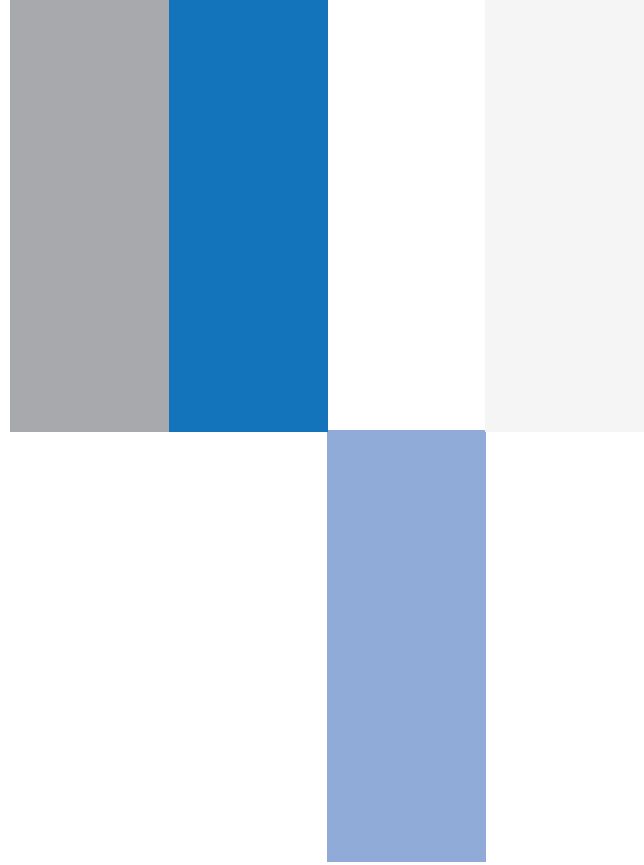





MODU LAR MODU LAIRE

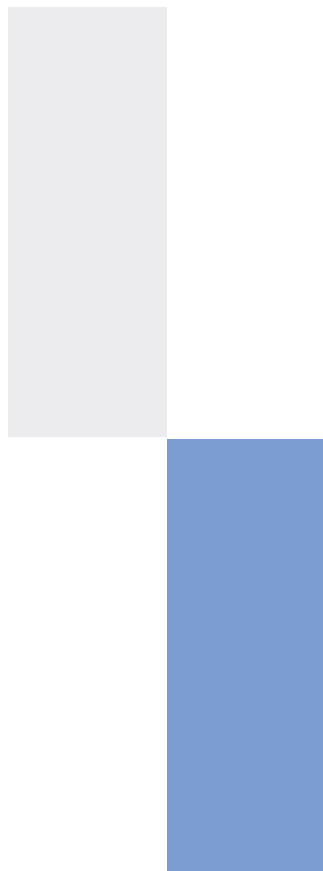

MIMO is a true demountable wall system. Which means it is installed over existing flooring, accommodates all kinds of doors and storage systems, can be fully wired and can be easily moved and reconfigured. So if you staff up, you can switch it up. If you change your mind, you can change your walls. With MIMO, you not only get the most minimal frame, you also get the least amount of fuss.

MIMO est un véritable mur démontable. Étant installé sur le couvre plancher existant, MIMO peut facilement être déplacé et reconfiguré. Il peut également accommoder tous les types de portes. Qu'elles soient coulissantes; battantes; à charnières; à pivots; en verre ou en bois. MIMO peut également inclure des systèmes électriques modulaires ainsi que le câblage réseau et la téléphonie. Si vous changez d'idée, vous pouvez changer vos murs à votre guise. Avec MIMO vous n'avez pas seulement un minimum de pièces, vous avez un minimum de dérangement lors de l'installation ou de la reconfiguration.

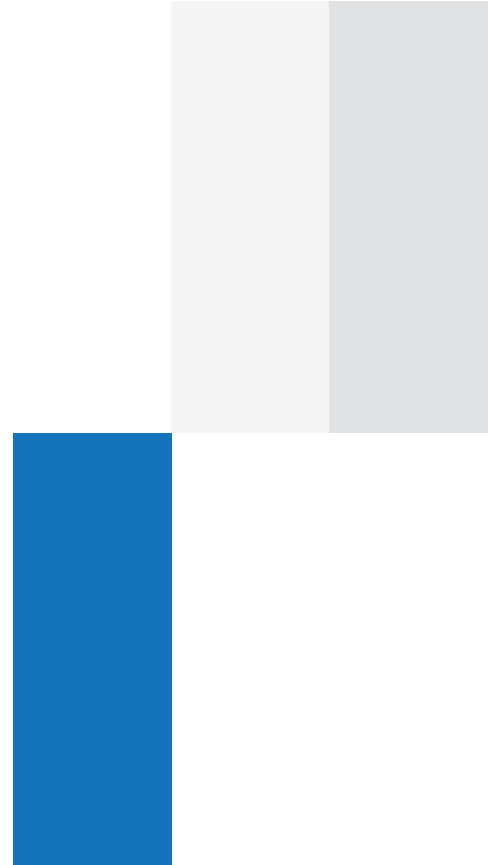

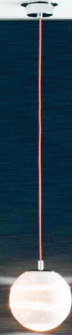

MATE RIALS MATE RIAUX





As long as it can be glazed, we can make a wall out of it. Which means your options are almost endless. And MIMO frames come in any of 17 carefully-selected, design-savvy standard finishes and colors; custom colors are limited only by your imagination. Most important, because our frame and brackets are so slim, you'll see more of whatever material you choose.

11

Du moment que vous utilisez des matériaux allant de $\frac{1}{4}$ " à $\frac{3}{4}$ " nous pouvons en faire une cloison. En verre, bien sûr, mais également en polycarbonate, en bois, en tissus, en acier, en aluminium peint, en mélamine, en gypse peint, ou avec un tableau marqueur. Ce ne sont que quelques exemples, la limite est votre imagination. Tous ces matériaux peuvent s'insérer dans nos extrusions qui sont disponibles dans 17 couleurs et textures soigneusement choisies. Il est également possible de personnaliser la couleur des extrusions et, parce que nos pièces sont si fines, vous verrez beaucoup plus les matériaux que vous aurez choisi.

GLASS PANELS

CLEAR TEMPERED
FROSTED
LAMINATED
LOW IRON
ULTRA CLEAR
STAR FIRE
WRITEABLE
ETC

VERRE

TREMPÉ CLAIR
DÉPOLI A L'ACIDE
ULTRA CLAIR
LAMINÉ
SÉRIGRAPHIE
VERRE A AFFICHAGE
ETC

SOLID PANELS

WOOD VENEER
FABRIC TACK
PLASTIC LAMINATE
ACRYLIC
DECOR METAL
DRYWALL COVERED
WITH VINYL
PAINTED DRYWALL
ETC

PANNEAUX

PLACAGE DE BOIS
PANNEAUX RECOUVERTS
DE TISSUS
MÉLAMINE
MÉTAL DÉCORATIF
GYPSE PEINT
GYPSE RECOUVERT
DE VINYLE
ETC

EXTRUSIONS
EXTRUSIONS**MATE**
RIALS
MATÉ
RIAUX**G2**

Black - anodized
Noir - anodisé

**G2**

Architectural Bronze - anodized
Bronze Architectural - anodisé

**G2**

Medium Bronze - anodized
Bronze Médium - anodisé

**G1**

Clear - anodized
Clair - anodisé



G2

White Matte - powder coat
Blanc Mat - peinture-poudre

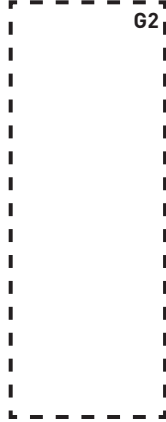

G2

Custom - powder coat
Personnalisé - peinture-poudre

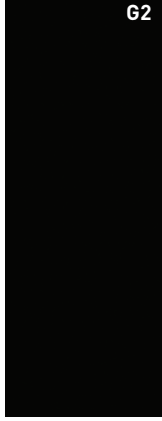

G2

Black Matte - powder coat
Noir Mat - peinture-poudre



G2

Charcoal - powder coat
Charbon - peinture-poudre



G2

Grey - powder coat
Gris - peinture-poudre



G2

Champagne - powder coat
Champagne - peinture-poudre

MANAG
EABLE
MANI
ABLE







MONTREAL, QUEBEC

330 MILES FROM NYC

2,474 MILES FROM LA

■ TORONTO

■ CHICAGO, IL

■ BOSTON, MA

■ SEATTLE, WA

■ KANSAS CITY, MO

■ NEW YORK, NY

■ PHILADELPHIA, PA

■ WASHINGTON, DC

■ LOS ANGELES, CA

■ DALLAS, TX

■ AUSTIN, TX

■ HOUSTON, TX

■ ORLANDO, FL

■ FT LAUDERDALE, FL

■ MIAMI, FL



**OTHER
DEMOUNTABLE PARTITIONS**

4,022 MILES FROM NYC

■ 6,472 MILES FROM LA

MIMO is flexible, but so is Muraflex.

We have showrooms in key major North American metropolitan areas, so you can see for yourself what's possible. We also have a complete engineering staff that can make even the most unique ideas come to life, quickly. And with our super tight lead times, you can get a distinctive, European look.

MIMO est polyvalent, tout comme

Muraflex. Nous avons des salles de montres dans les plus grosses villes en Amérique du Nord pour que vous puissiez voir nos possibilités. Nous avons une équipe complète d'ingénieurs pour rendre possibles toutes vos idées originales et ce, rapidement. Avec nos délais de livraison rapides, vous pouvez avoir une allure distincte et européenne.

MOTHER
NATURE
MÈRE
NATURE



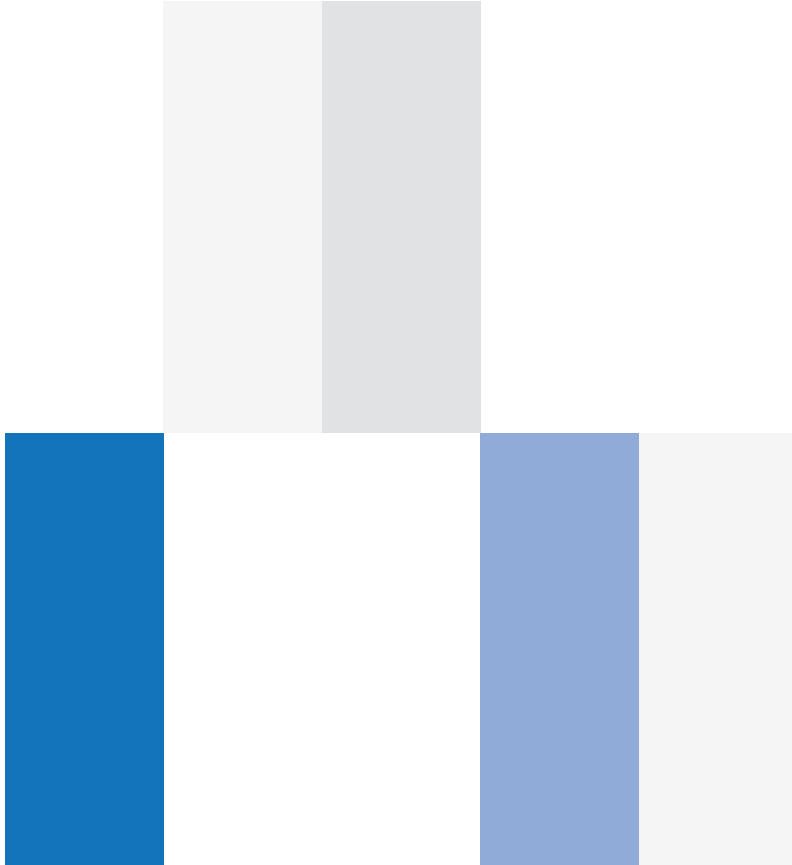

Being close benefits the environment as well as our customers. Choose MIMO and you'll get LEED points for everything from sourcing within 500 miles to using recyclable materials and increasing access to natural light. And of course, by using MIMO's slender frame to create open, modern, graceful interiors, you'll make fans of each person using the space every day.

19

L'utilisation des cloisons MIMO peut vous permettre d'obtenir des points LEED dans 9 catégories, selon le type de matériaux que vous utilisez. Étant conçues et fabriquées chez nous, vous demeurez dans la zone des 800 kilomètres pour l'utilisation de matériaux régionaux. Vous utilisez des matériaux recyclables et vous augmentez l'accès de la lumière dans votre environnement. Et, bien sûr, parce que vous utilisez les fines extrusions MIMO, vous créez des espaces ouverts, modernes, et "chics" qui créeront un impact positif sur vos employés et votre clientèle, à tous les jours.





MAGNI
FICENT
MAGNI
FIQUE





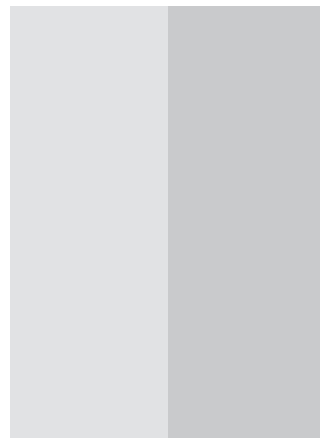



SEVEN





DET
AILS
DÉT
AILS

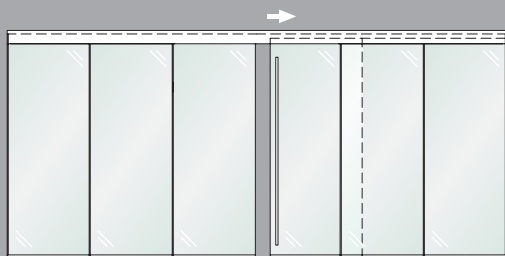

GLASS SLIDING DOORS SINGLE OR MULTIPLE
PORTE EN VERRE COULISSANTE SIMPLE OU MULTIPLE

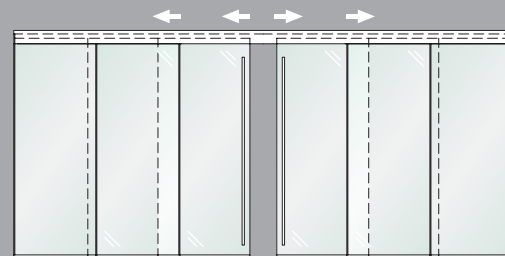
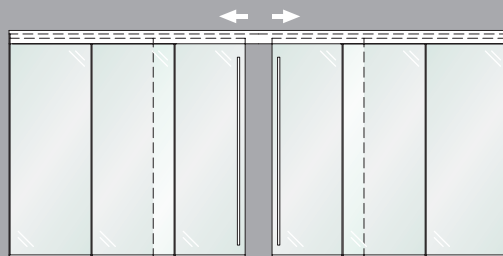

GLASS PIVOT/HINGE DOORS SINGLE GLAZING
PORTE EN VERRE PIVOTS/CHARNIÈRES VERRE SIMPLE



WOOD HINGE DOORS SINGLE GLAZING
PORTE EN BOIS SUR CHARNIÈRES VERRE SIMPLE



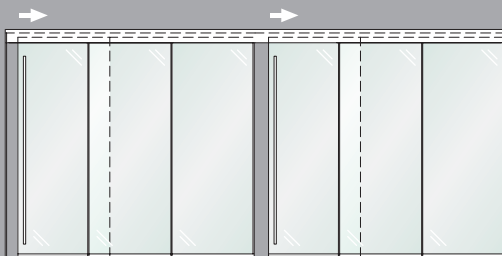

SHAPE VERSATILITY
VERSATILITÉ DE FORME



MATERIAL VERSATILITY
VERSATILITÉ DE MATÉRIAUX

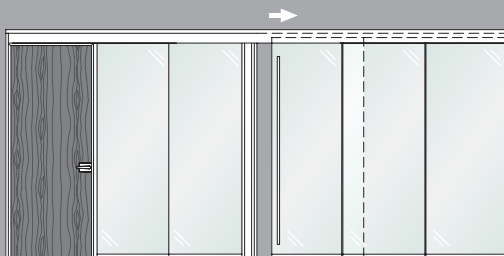

DOUBLE GLAZED ACOUSTICS
CLOISONS ACOUSTIQUES VERRE DOUBLE

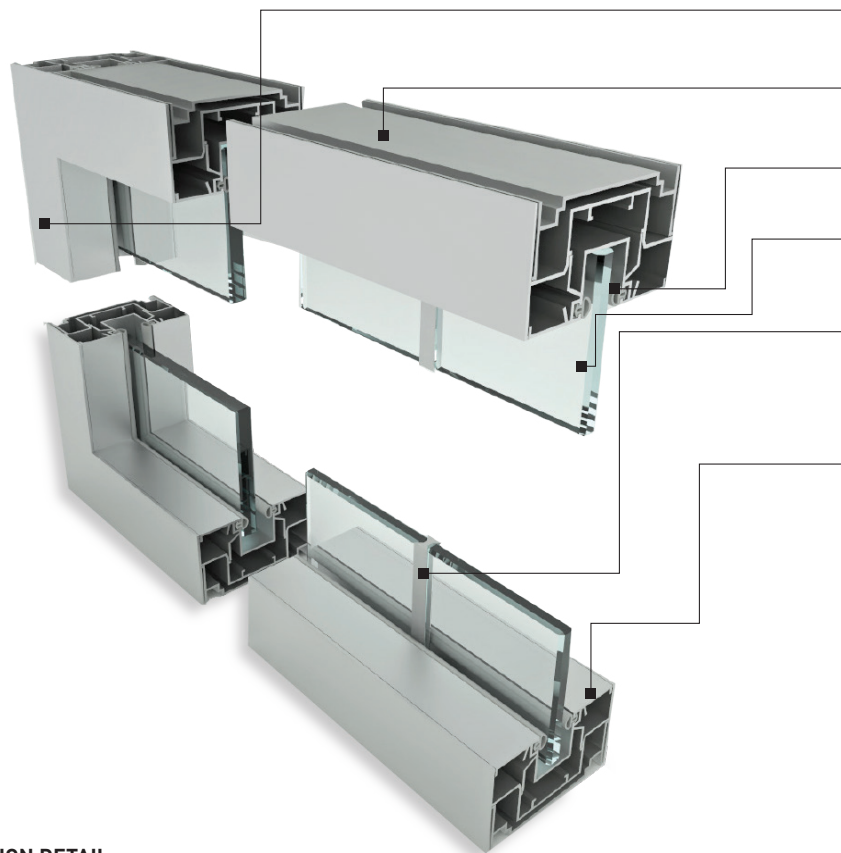

JAMB MULLION WITH CENTER GLASS ADAPTOR
MENEAU DE JAMBAGE AVEC ADAPTEUR DE VERRE CENTRÉ

HEAD MULLION WITH CENTER GLASS ADAPTOR
MENEAU DE TÊTE AVEC ADAPTEUR DE VERRE CENTRÉ

ACOUSTIC GASKETS
JOINT ACOUSTIQUE

CENTERED SINGLE GLASS
VERRE SIMPLE CENTRÉ

ALUMINUM OR POLYCARBONATE TRIM
 GLASS TO GLASS JUNCTION
MOULURE EN ALUMINIUM OU EN POLYCARBONATE
 JONCTION VERRE CONTRE VERRE

SILL MULLION WITH CENTER GLASS ADAPTOR
MENEAU DE LISSE AVEC ADAPTEUR DE VERRE CENTRÉ

SECTION DETAIL
DÉTAIL EN COUPE

CENTER GLAZED VERRE CENTRÉ

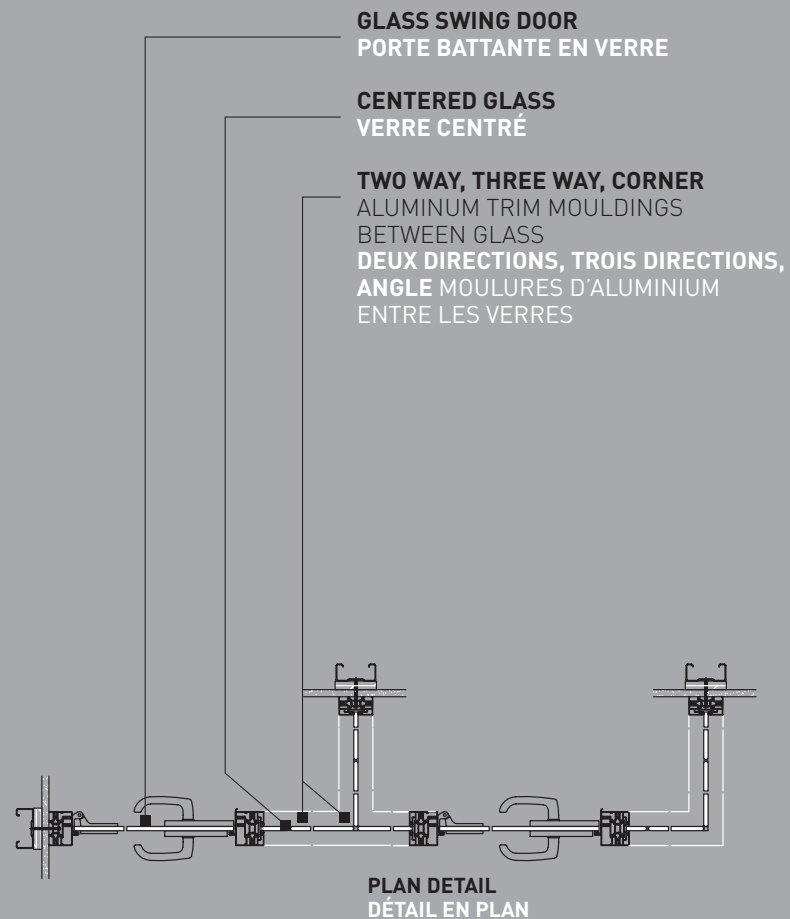
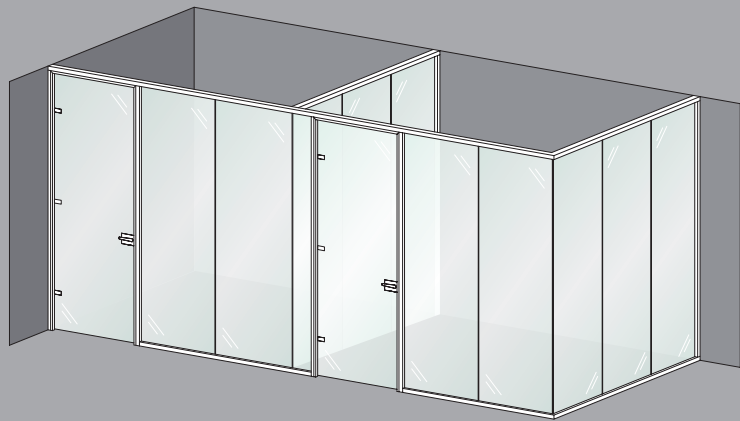

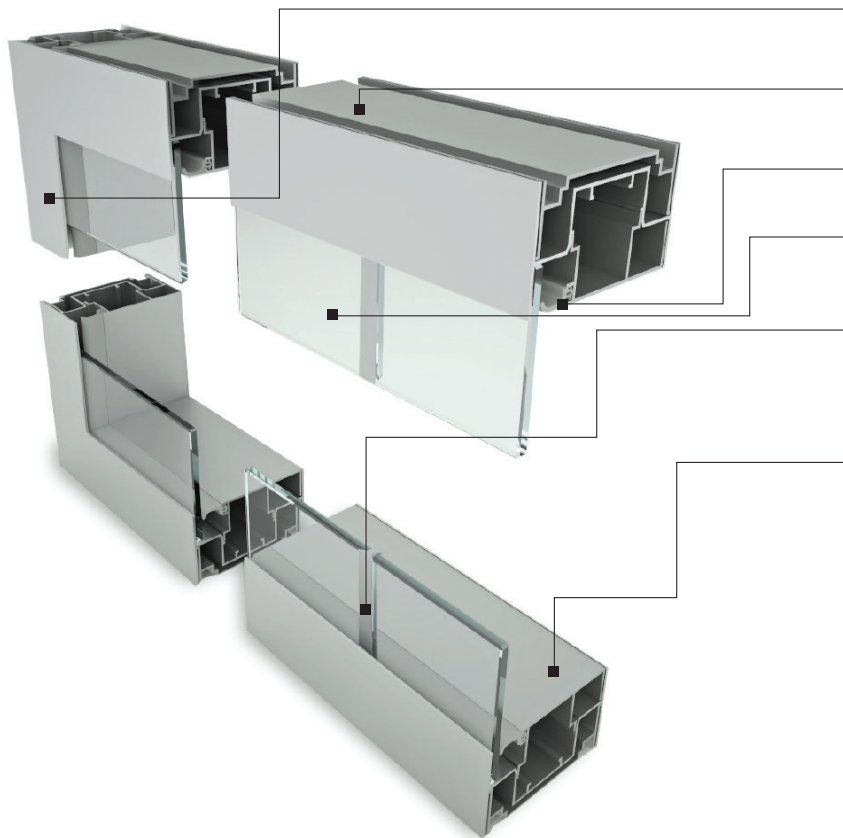

JAMB MULLION WITH OFFSET GLASS ADAPTOR
MENEAU DE JAMBAGE AVEC ADAPTEUR DE VERRE DÉCENTRÉ

HEAD MULLION WITH OFFSET GLASS ADAPTOR
MENEAU DE TÊTE AVEC ADAPTEUR DE VERRE DÉCENTRÉ

ACOUSTIC GASKETS
JOINT ACOUSTIQUE

OFFSET SINGLE GLASS
VERRE SIMPLE DÉCENTRÉ

ALUMINUM OR POLYCARBONATE TRIM
GLASS TO GLASS JUNCTION
MOULURE EN ALUMINIUM OU EN POLYCARBONATE
JONCTION VERRE CONTRE VERRE

SILL MULLION WITH OFFSET GLASS ADAPTOR
MENEAU DE LISSE AVEC ADAPTEUR DE VERRE DÉCENTRÉ

SECTION DETAIL
DÉTAIL EN COUPE

OFFSET GLAZED VERRE DÉCENTRÉ

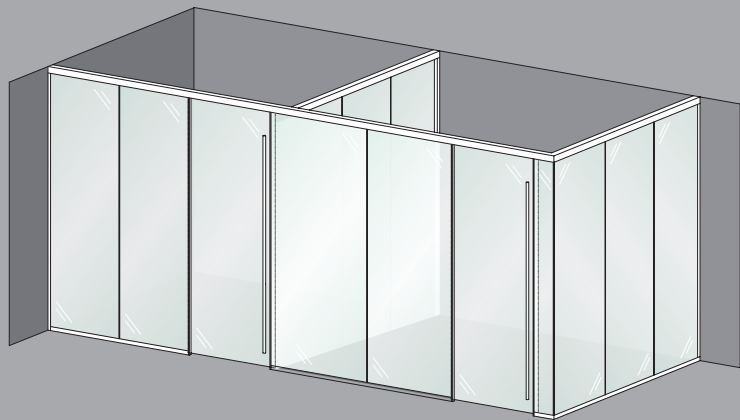

OFFSET GLASS
VERRE DÉCENTRÉ

SLIDING DOOR GLASS
PORTE COULISSANTE EN VERRE

TWO WAY, THREE WAY, CORNER
ALUMINUM TRIM MOULDINGS
BETWEEN GLASS
DEUX DIRECTIONS, TROIS DIRECTIONS,
ANGLE MOULURES D'ALUMINIUM
ENTRE LES VERRES

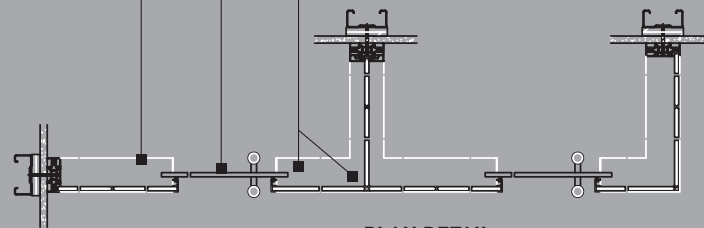

PLAN DETAIL
DÉTAIL EN PLAN

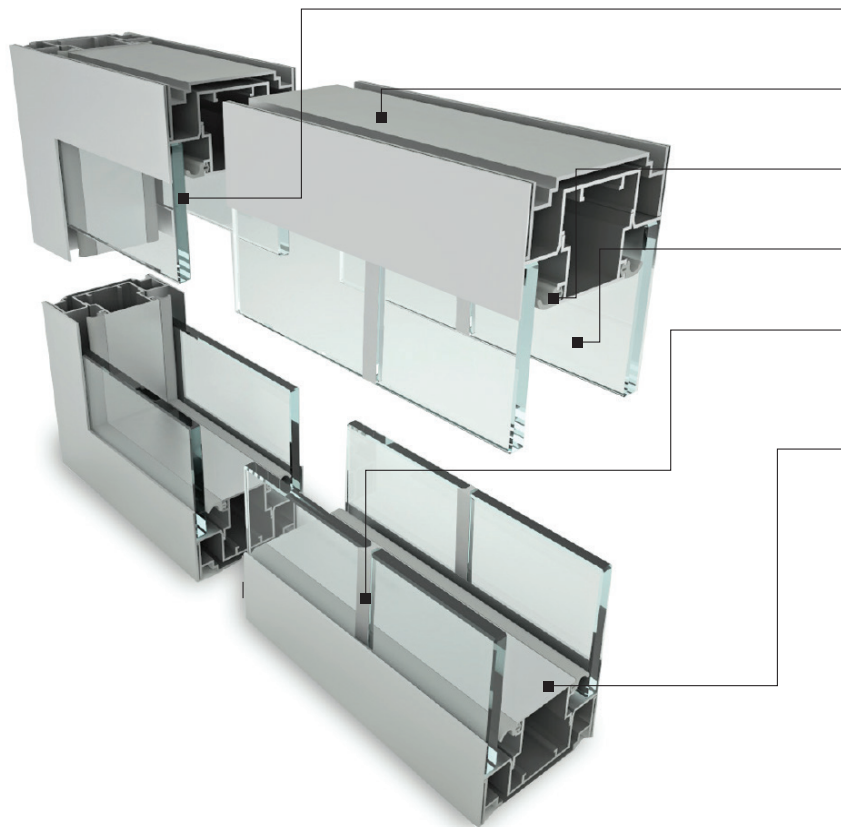

INSULATED PANELS OR GLASS PANELS
PANNEAUX ISOLÉS OU PANNEAUX DE VERRE

HEAD MULLION WITH SYMMETRICAL OFFSET ADAPTOR
MENEAU DE TÊTE AVEC ADAPTEUR SYMÉTRIQUE

ACOUSTIC GASKETS
JOINT ACOUSTIQUE

DOUBLE GLASS 2 1/2" AIR SPACE
DOUBLE VERRE ESPACÉ DE 2 1/2"

ALUMINUM OR POLYCARBONATE TRIM
 GLASS TO GLASS JUNCTION
MOULURE EN ALUMINIUM OU EN POLYCARBONATE
 JONCTION VERRE CONTRE VERRE

SILL MULLION WITH SYMETRICAL OFFSET ADAPTOR
MENEAU DE LISSE AVEC ADAPTEUR SYMÉTRIQUE

SECTION DETAIL
DÉTAIL EN COUPE

DOUBLE GLAZED VERRE DOUBLE

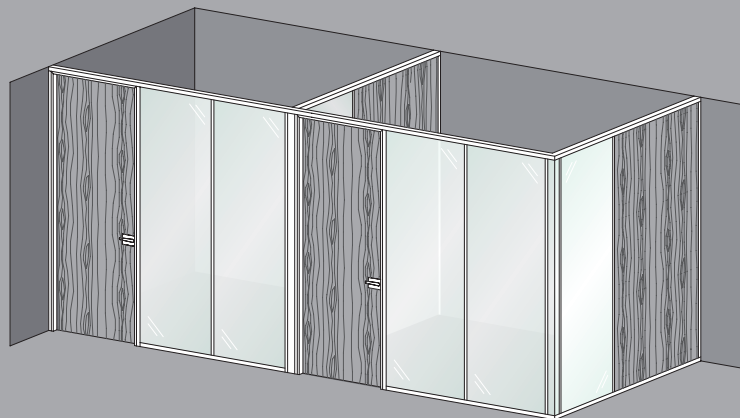

1 3/4" WOOD DOOR
PORTE DE BOIS 1 3/4"

DOUBLE GLASS 2 1/2" AIR SPACE
VERRE DOUBLE ESPACÉ DE 2 1/2"

INSULATED PANELS
PANNEAUX AVEC ISOLANT

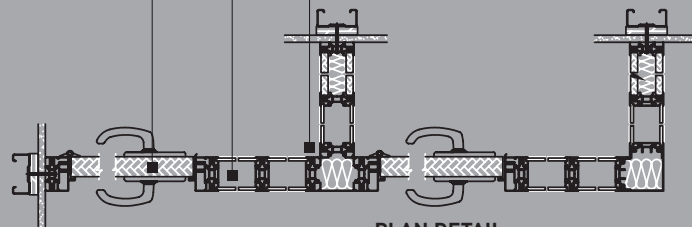

PLAN DETAIL
DÉTAIL EN PLAN



CENTER GLAZED
VERRE CENTRÉ



OFFSET GLAZED
VERRE DÉCENTRÉ



DOUBLE GLAZED
VERRE DOUBLE

ADJUSTABLE SILL+JAMB LISSE+JAMBAGE AJUSTABLE

Depending on different configurations of the system, MIMO ranges on a total travelling distance of a minimum of 1" to a maximum of 2".

Dépendamment de la configuration du système, MIMO peut atteindre une ajustabilité allant de 1" jusqu'à 2".

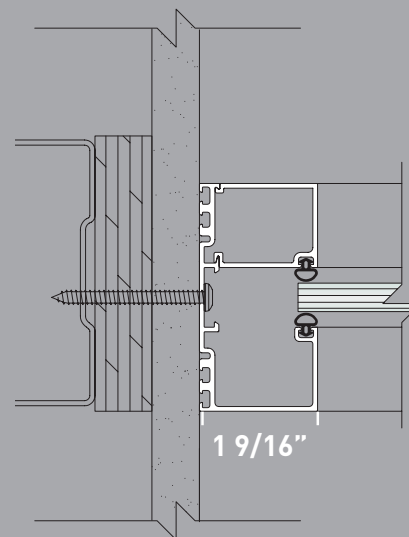
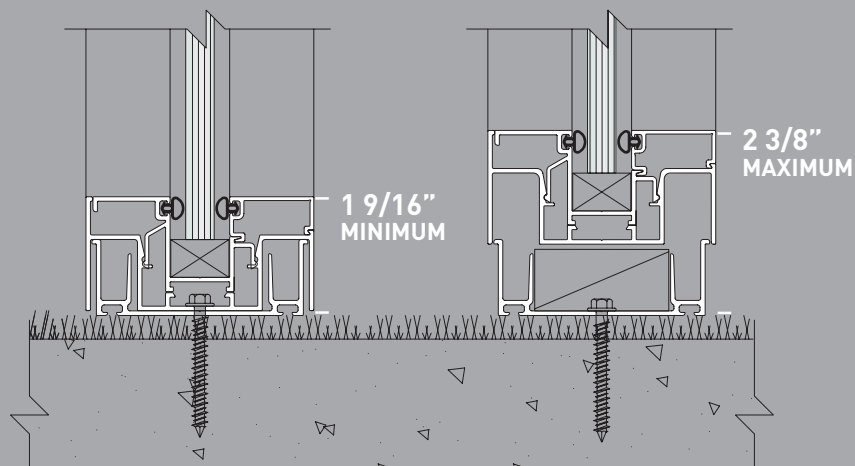



GLASS JUNCTIONS JONCTIONS DE VERRE

POLYCARBONATE
POLYCARBONATE



GLASS TO GLASS
VERRE CONTRE VERRE



GLASS T-CONDITION
JONCTION EN T



CORNER CONDITION
JONCTION EN COIN

ALUMINIUM
ALUMINIUM



GLASS TO GLASS
VERRE CONTRE VERRE



GLASS T-CONDITION
JONCTION EN T



CORNER CONDITION
JONCTION EN COIN

DOOR DETAILS DÉTAILS DES PORTES

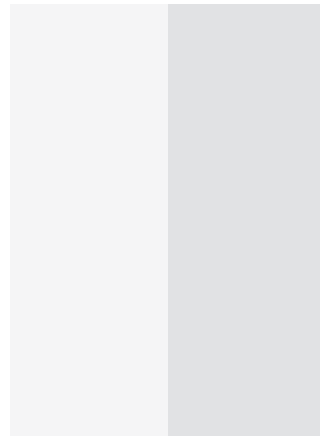
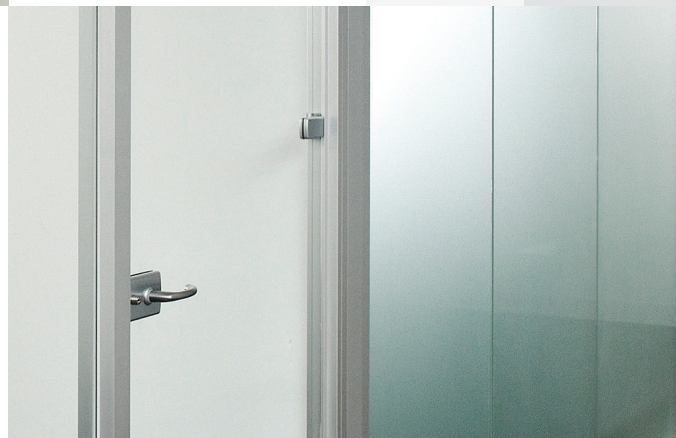
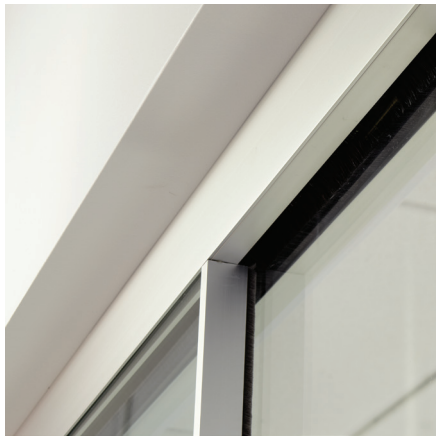

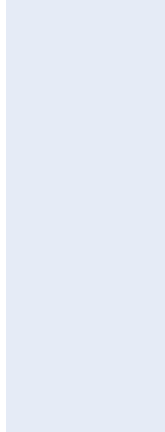





**HARD
WARE
QUINCA
ILLERIE**



MIMO frames and hardware are carefully engineered to exacting standards that provide you with the greatest strength, durability, and reliability, in the slimmest profile possible. Minimal. Modern. It's all in our name.

Les cadres et la quincaillerie MIMO sont conçus avec précision pour assurer un assemblage précis et durable. La finesse de ses lignes, minimales, modernes, s'accordent avec son nom.





LADDER PULLS POIGNÉES TUBULAIRES + LEVER SETS POIGNÉES À LEVIER

Ladder pulls are available in both square and round profiles and ranging from 7" to 84" in length.

Les poignées tubulaires sont disponibles en profile carré ou rond, et varient entre 7" et 84" en longueur.



**SQUARE
LADDER PULL
POIGNÉE
TUBULAIRE CARRÉE**



**ROUND
LADDER PULL
POIGNÉE
TUBULAIRE RONDE**



**SQUARE LOCKING
LADDER PULL
POIGNÉE TUBULAIRE
CARRÉE VERROUILL-
ABLE**



**ROUND LOCKING
LADDER PULL
POIGNÉE TUBULAIRE
RONDE VERROUILLABLE**



LEVER SET
MFHDW-027
POIGNÉE À LEVIER
MFHDW-027



LEVER SET
MFHDW-028
POIGNÉE À LEVIER
MFHDW-028



LEVER SET
MFHDW-28B
POIGNÉE À LEVIER
MFHDW-28B



LEVER SET
MFHDW-030
POIGNÉE À LEVIER
MFHDW-030

LEATHER WRAPPED ENVELOPPÉ DE CUIR



BLACK
NOIR



BEIGE
BEIGE



BROWN
MARRON



RED
ROUGE



WOODEN PULLS POIGNÉES EN BOIS



MAHOGANY
ACAJOU



ASH
FRÊNE



WENGE
WENGÉ



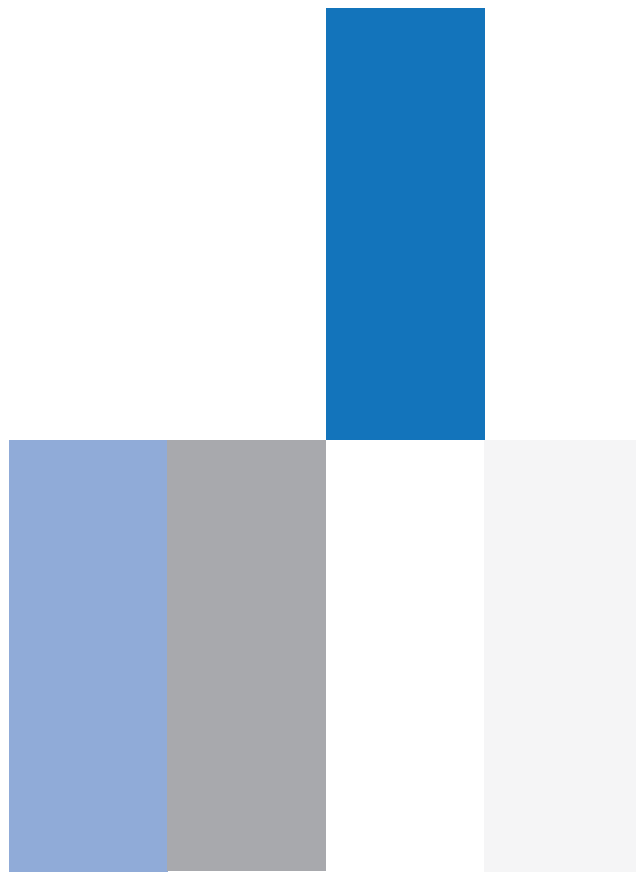



muraflex

1253 Rue Dickson
Montréal, Québec
Canada, H1N 3T4

T 1.866.962.3632

T 450.462.3632

F 450.462.7972

E info@muraflex.com

W muraflex.com

